



OPERATOR'S INSTRUCTIONS AND PARTS LIST

AIR CONCRETE BREAKER MODEL TPB-501SV

Symbol

Please observe all safety precautions listed below.

 **WARNING:** This may cause an accident resulting in injury or death if it is not observed.

 **CAUTION:** This may cause injury, damage or trouble to the air tool or equipment if it is not followed.

WARNING

To reduce risk of injury, everyone using, installing, repairing, maintaining changing accessories on, or working near this tool **MUST** read and understand these instructions before performing any such task.

DO NOT DISCARD-GIVE TO USER



Do not use an Air Breaker until this safety instruction has been read and understood completely.
This manual is necessary to help you to use the Air Breaker correctly.

WARNING

Do not use an Air Breaker before reading this safety instruction manual.
Obey all of the safety measures indicated in this manual

FOR DETAILED INFORMATION ABOUT TOKU AIR TOOLS AND EQUIPMENT
CONTACT TO :

Air & Allied Sales (Pacific) Pty Ltd

Head Office: 1/50 Success Street, Acacia Ridge, Brisbane, QLD, 4110 AUSTRALIA

Phone: +61 7 3272 7999

15th edition

Safety precaution when using an Air Tool

Always obey the law and the safety regulations during work.

Always wear proper clothing and use other protective equipment when operating an air tool.

WARNING

Always wear ear protection to prevent possible ear damage when operating an air tool at high noise level or for a long time.

WARNING

Heavy vibration from an air tool may result in injury to the hand, fingers and wrist of operator during a long period of operation.

Stop using an air tool if you feel pain or any problem concerning the use of an air tool. Resume use of an air tool after consulting with a doctor, confirming that there is no problem concerning the use of an air tool.

Always wear suitable working clothes when operating an air tool because a necktie or clothing with an open sleeve may get caught in the air tool during operation and may result in danger to the operator.

Always wear the following protective equipment during the operation of an air tool to protect the operator from getting hurt according to the type of the operation.

Gloves Dust proof mask Helmet Protective goggles Ear protection Working shoes
Setting up a dust vacuum device is recommended when operating an air tool indoors.



Rules for the purpose of safety, which must be observed

WARNING

It is absolutely necessary to receive permission from the manufacture for the purpose of any modifications concerning the air tool.

The manufacturer will not assume any responsibility concerning an accident resulting in injury, death or any trouble from an air tool due to the reconstruction without the permission of the manufacturer.

Always use GENUINE tool replacement parts recommended by the manufacturer when replacing any part of an air tool.

There must be a sticker or a sign indicating matters concerning the safety precautions and maintenance on a new air tool.

It is always important to keep this sticker of sign to be clean enough to read. It is available from the distributor of the manufacturer if it is lost.

Checking the workplace or work site

Do not permit people except operators get near the work site. Especially it is very dangerous to permit children into the working area.

Arranging and preparing the working area are the starting lines to ensure safety operation. Always maintain the work site or workshop to be in order and make sure they have enough light.

Always observe the rules such as warning, caution, manual, etc written in the working area.

Do not use the tool in explosive conditions.

Maintenance and replacement of the chisel

WARNING

Turn the valve cock of the compressor completely to the stop position, hold down the throttle valve and release the pressure in the hose completely before inspecting and replacing the chisel.

Inspect the chisel regularly, replace with a new one if any defect, such as a crack is found. Using a chisel with any defect is very dangerous.

Make sure that the tip of the chisel is sharp once again.

Hose connection

WARNING

Install the metallic cap of the air hose onto the body of the air tool firmly. The metallic cap will come off and cause the hose to run amuck due to vibration if the metallic cap is used in a loose condition. This will be very dangerous.

Check for damage of the air hose and in the connection part of the air tool body.
Confirm that there is no dust or dirt.
Do not point the air hose at anyone.
Never use compressed air to clean cloth.

Operation

CAUTION

Keep your feet away from the chisel. There would be a risk for injury if the chisel drops onto the operator's foot when the chisel is broken.

Never operate an air tool at an air pressure over the limit of the air tool.
Confirm that the retainer of the chisel is locked firmly before starting the air tool.
Never start an air tool without a chisel.
Always hold an air tool with both hands. Confirm that the handle is clean without any grease or oil.
Do not place the air tool on a person's foot.
Always keep well balanced during operation.
Never get on a tool. For example, do not put one foot on the handle of the air tool.
This may become a reason to get hurt especially when the air tool is broken.
Investigate the material of the work. For example, when using the tool for electric and telephone cable, water and drain pipe, etc, inspect for hidden cable or pipe underground before operating an air tool.
In case the chisel hits something during operation, stop the air tool immediately.
Restart the tool after the danger is cleared.

Service and maintenance

Turn the valve cock of the compressor completely to the stop position, hold down the throttle valve and release the pressure in the air hose completely before disconnecting an air tool.
Read and understand the instruction manual correctly. Contact with the selling agent or distributor of the manufacturer for further service information if necessary.
When it is necessary to use solvent to clean parts, be sure it is within the safety standards first, then use the solvent at a place with good ventilation.

Never be careless

Always concentrate on the work.
Always use common sense.
Eye vision and reaction deteriorate significantly in fatigue conditions after taking medicine, or drinking alcohol.
Never use an air tool when you are under the influence of these conditions.

Always direct exhaust away from yourself and others in the area.

**Always disconnect tool from the air supply when not in operation.
If quick-disconnect couplings are used, separate the coupling from the tool with a leader hose.**

Always make sure cutting chisel is securely latched in the tool before depressing throttle trigger.

Always hold cutting tool down firmly on the work before depressing throttle trigger.

Operator's instruction

Preparations before operation

Check following matters before operation.

Compressor

Capacity of the compressor is sufficient. Minimum requirement 20hp, 60CFM at 90psig (6.2bar)
Whether the drain has been removed.

Air Hose

Whether there is any damage to the air hose. Whether the size and length is correct.
Clean the interior of the air hose using compressed air.
When using two or more tools, all except leader hose should be 1" or large.
(See diagram above for piping and fittings.)

Inspection of the Air Breaker

Whether there is looseness in the screw thread areas.
Whether there is a crack or breakage in the main body.

Inspection of chisel

Whether the chisel is suitable for the shank of the Air Breaker.
Whether the chisel is suitable for the work.
Whether there is wear or cracks.
Whether the chisel is mounted correctly.

Wearing protective equipment

Whether the helmet, protective goggles, ear protection, gloves and working shoes are worn correctly.

Air Supply

Whether the air pressure is suitable. For best operation, supply tool with 90psig (6.2bar) of clean, dry air.
Higher pressure drastically reduces tool life and can void warranty. (600kPa for max)

Lubrication

To flush out GUM and DIRT – you should do the following two steps EACH DAY.

1. (Before the shift), pour a liberal quantity of gum solvent oil into the tool's air inlet.
2. Connect tool to air line and operate. Repeat this procedure before storing the tool.

Air line lubricator should be used in conjunction with the integral oiler.

Repeat this procedure before storing the tool.

Whether the oil is suitable for the Air Breaker. (turbine oil equivalent to ISO VG46)

Whether lubrication has been performed. (at least twice day)

The importance of adequate and continuous lubrication cannot be overemphasized.

A few minutes operation without oil may severely damage the valve parts, cylinder and piston.

Hose Connection

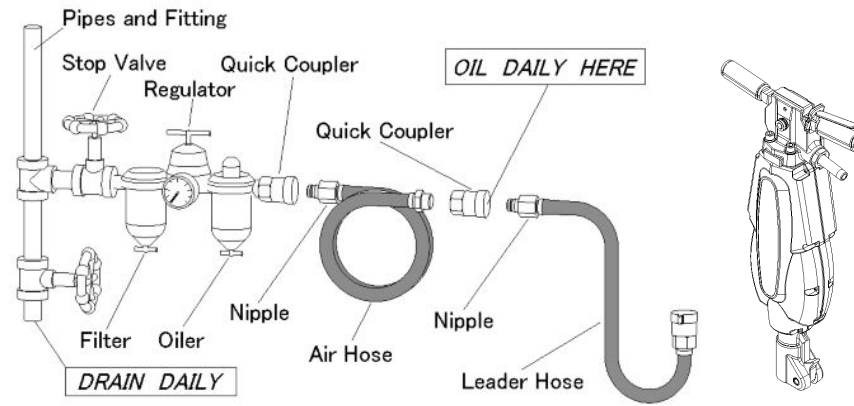

Whether there is any dust, or damage to the air connection portion.
Whether the air hose is tight enough.

Operation guide

Maintain good balance on both feet. Keep proper distance from the chisel of the Air Breaker.
Never put your hand near the chisel when using the Air Breaker horizontally.
Push the Air Breaker against the object firmly using the handle before turning the throttle valve down.
Obey the law and safety regulations.

Inspection and maintenance

WARNING

Turn valve cock of the compressor to the stop position first, hold down the throttle and release the excess pressure in the air hose completely, then disconnect the Air Breaker from the air hose and finally inspect the Air Breaker.

Inspection and storage for an Air Breaker

Clean the exterior surface using a cloth.
Regularly inspect the tightening torque on the bolts.
Inspect whether there are any cracks or damage in the Air Breaker.

Storage of the Air Breaker

Apply 3 cc of oil from the air inlet. operate the Air Breaker for about 5 seconds after completing work.
Repeat above operation 2-3 times before storing the Air Breaker.
Put a cap on the air inlet of the Air Breaker to prevent any dust or foreign material from entering the Air Breaker. Keep the Air Breaker in a dry place.

Loss of power/erratic action (possible causes)

1. Reduced compressor output.
2. Excessive drain on air line.
3. Moisture or restricted pipe, hose or fittings.
4. Improper size or poor condition of pipe, hose or fittings.
5. Incorrect shank size of chisel, or excessively worn shank.
6. Free running (or blank blow) can cause damage to the tool. Always hold the tool down to the work.
7. Loosening of side bolts or back head bolts will cause loss of power and can cause damage to the tool.
Periodic inspection of bolt torque at regular intervals (at least once a week if tool is being used regularly) is recommended.

If everything else appears to be in order, then disassemble tool, replace worn or damaged parts, clean, reassemble and lubricate.

Replacement parts

Always use **GENUINE TOKU TOOL Replacement Parts**.

When replacement parts are required, order by Part Number and Description from the Parts List.

Air consumption at air pressure of 600kPa

1.4 m³/min

Sound levels (2000/14/EC amended by 2005/88/EC)

Measured sound power level	106.87 dB(A)
Guaranteed sound power level	108 dB(A)

Vibration value (ISO 28927-10)

Declared vibration emission value a_{hd}	Uncertainty K
5.9 m/s ²	1.07 m/s ²

Location of Serial number, Year of manufacture and Name plate

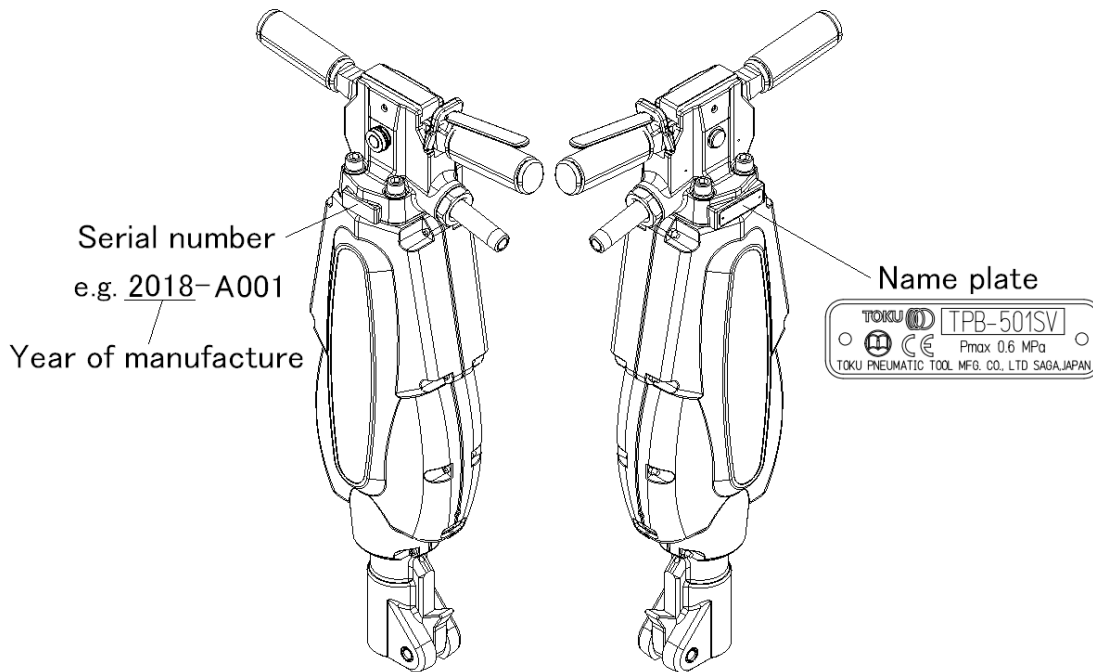

(2) We :

TOKU PNEUMATIC TOOL MFG. CO., LTD.

5733, Minobaru, Miyaki-machi, Miyaki-Gun, Saga Japan

(3) Technical file authorized representative :

S.Fukuyama, Manager, Manufacturing Div.

TOKU PNEUMATIC TOOL MFG. CO., LTD.

5733, Minobaru, Miyaki-machi, Miyaki-Gun, Saga Japan

(4) declare that the product(s) : **CONCRETE BREAKER**

(5) Model/Type : TPB-501SV

(6) Version(s) : TPB-501SV, TPB-501MSV

(7) Starting Serial No. : 2018-A003

(8) is in conformity with the requirement of the council Directives on the approximation of the laws of the Member States relating :

(9) to "**Machinery**" 2006/42/EC

and "**the noise emission in the environment by equipment for use outdoor**" 2000/14/EC

amended by 2005/88/EC

(10) applicable harmonized standard(s) : ISO 12100:2010, ISO 11148-4:2010

(11) Place and date : Saga Japan, 10/08/2015

(12) NAME and POSITION of issuer : **S.Fukuyama, Manager, Manufacturing Div.**



ESPAÑOL (SPANISH)

(1) **DECLARACION DE CONFORMIDAD CE**- (2) Nosotros **TOKU**- (3) Archivo técnico disponible en - (4) declaramos que el producto : - Rompedor de hormigón - (5) tipo de máquina : - (6) versión : - (7) con comienzo de nº de serie : - (8) es conforme a los requisitos de la Directiva del Consejo sobre la aproximación de las leyes de los Estados con relación - (9) a la **"maquinaria" 2006/42/CE** y **"la emisión de ruido en el entorno de las máquinas de uso al aire libre"**, la **Directiva 2000/14/CE** modificada por **2005/88/CE** - (10) normas armonizadas aplicadas : - (11) Nombre y cargo del expedidor : - (12) Fecha

DEUTSCH (GERMANY)

(1) **EG-KONFORMITÄTSERKLÄRUNG** - (2) Wir, **TOKU** - (3) Technische Datei beim EU - (4) erklären hiemit, daß das (die) Produkt(e) : - Beton Hammer - (5) Typ(en) : - (6) version : - (7) serien Nr. beginn : - (8) den Anforderungen der EG-Richtlinie zur Angleichung der Rechtsvorschriften der Mitgliedsstaaten - (9) für **"Maschinen" 2006/42/EG** und **"die Lärmemission in die Umwelt von Geräten und Maschinen zur Verwendung im Freien" 2000/14/EG** geändert durch **2005/88/EG** - (10) geltende harmonisierte Norm(e) : - (11) NAME und EIGENSCHAFT des Ausstellers : - (12) Datum

FRANÇAIS (FRENCH)

(1) **DECLARATION DE CONFORMITE** - (2) Nous **TOKU** - (3) Dossier technique disponible auprès du siège social - (4) déclarons que les produits : - Brise Béton - (5) type : - (6) version : - (7) premier N° de série : - (8) est (sont) en conformité avec les exigences de la Directive du conseil, concernant les législations des états membres relatives - (9) aux **"Machines" 2006/42/CE** et **"les émissions sonores dans l'environnement des matériels destinés à un usage extérieur" 2000/14/CE** modifiée par **2005/88/CE** - (10) Norme(s) harmonisée(s) applicable(s) : - (11) NOM et FONCTION de l'émetteur : - (12) Place et data

ITALIANO (ITALIAN)

(1) **DICHIARAZIONE DI CONFORMITÀ CE** - (2) La Società : **TOKU** - (3) File tecnico disponibile dal - (4) dichiara che il(i) prodotto(i) : - Martello Pneumatico - (5) tipo : - (6) version : (7) avente numeri di serie che partono dal suffisso : (8) è (sono) in conformità con le esigenze previste dalla Direttiva del Consiglio, sulle legislazioni degli Stati membri relative : - (9) alle **"macchine" 2006/42/CE** e **"l'emissione acustica ambientale delle macchine per uso esterno" 2000/14/CE** modificata dalla **2005/88/CE** - (10) norma(e) armonizzate(e) applicabile(i) : - (11) NOME e FUNZIONE del dichiarante - (12) Data

PORTUGUÊS (PORTUGUESE)

(1) **DECLARAÇÃO DE CONFORMIDADE CE** - (2) Nós **TOKU** - (3) Ficheiro técnico disponível na - (4) declaramos que o produto : - Martelo Demolidor - (5) tipo de máquina : - (6) versão : - (7) N.º inicial de Série - (8) está em conformidade com os requisitos da Directiva do Conselho, referente às legislações dos Estados-membros relacionados com : - (9) **"maquinaria" 2006/42/CE** e **"de emissões sonoras para o ambiente dos equipamentos para utilização no exterior" 2000/14/CE** alterada pela **2005/88/CE** - (10) Normas harmonizadas aplicáveis - (11) Nome e cargo do emissor : - (12) Data

NEDERLANDS (DUTCH)

(1) **E.G.-VERKLARING VAN OVEREENSTEMMING** - (2) De firma : **TOKU** - (3) Technisch bestand verkrijgbaar - (4) verklaart hierbij dat het (de) produkt(en) : - Beton Breekhamer - (5) type : - (6) versie : - (7) vanaf serie nummer : - (8) in overeenstemming is (zijn) met de vereisten van de richtlijn van de Raad inzake de onderlinge aanpassing van de wetgevingen van de lidstaten betreffende : (9) **"machines" 2006/42/EG** en **"de geluidsemissie in het milieu door materieel voor gebruik buitenshuis" 2000/14/EG** gewijzigd bij **2005/88/EG** - (10) geldige geharmoniseerde norm(en) - (11) NAAM en FUNCTIE van de opsteller : - (12) Datum

ΕΛΛΗΝΙΚΑ (GREEK)

(1) **ΔΗΛΩΣΗ ΠΙΣΤΟΤΗΤΑΣ ΕΚ** - (2) Η εταιρεία : **TOKU** - (3) Τεχνικός φάκελος διαθέσιμος - (4) δηλώνει υπεύθυνα ότι το(τα) προϊόν(-ντα) : - Κρουστικό Αερόφυρο - (5) τύπου(-ων) : - (6) εναλλακτικοί τύποι : - (7) αρχή σειράς No. : - (8) είναι σύμφωνο(-α) προς τις απαιτήσεις της Οδηγίας του Συμβουλίου που αφορά την προσέγγιση των νομοθεσιών των κρατών τις σχετικές με : - (9) τα **"μηχανήματα" 2006/42/ΕΚ** και **"την εκπομπή θορύβου στο περιβάλλον από εξοπλισμό προς χρήση σε εξωτερικούς χώρους" 2000/14/ΕΚ** όπως τροποποιήθηκε από **2005/88/ΕΚ** - (10) εφαρμοστέο(-α) εναρμονισμένο(-α) πρότυπο(-α) : - (11) ΟΝΟΜΑ και ΑΡΜΟΔΙΟΤΗΤΑ του δηλούντος : - (12) Ημερομηνία

Installation of Resin Insulator (Pair)

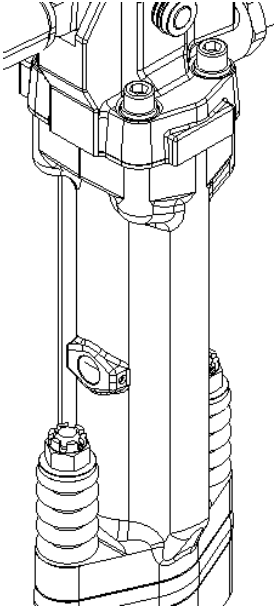
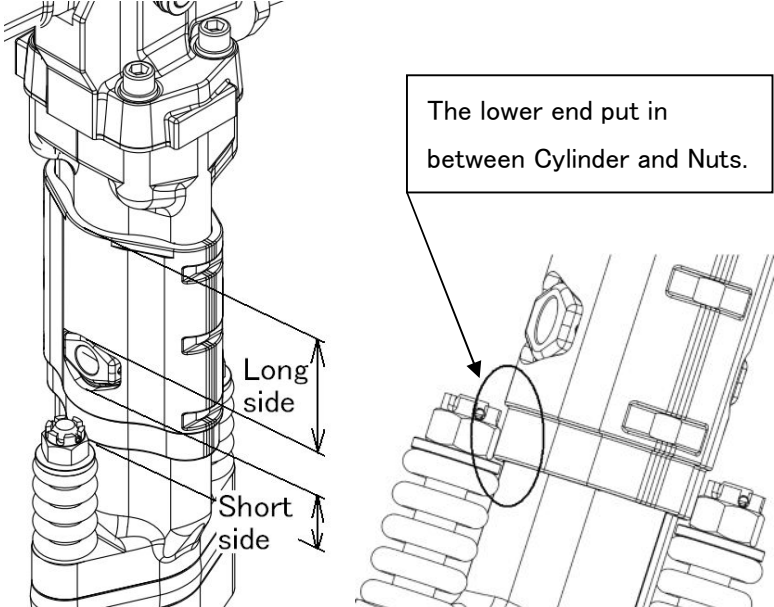
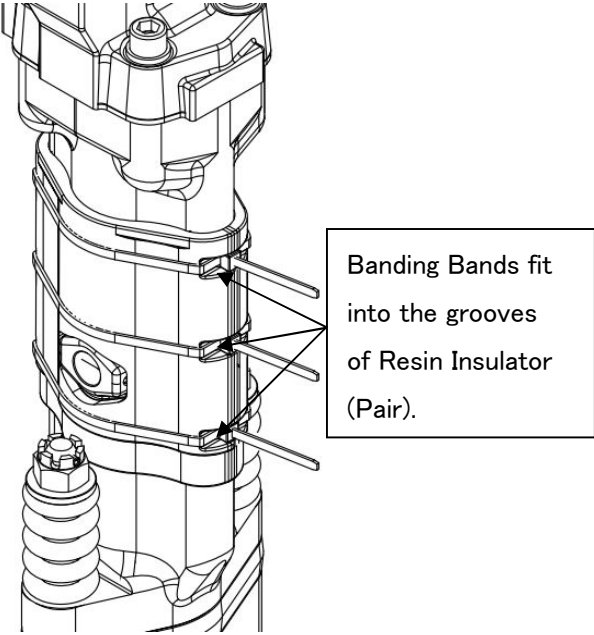
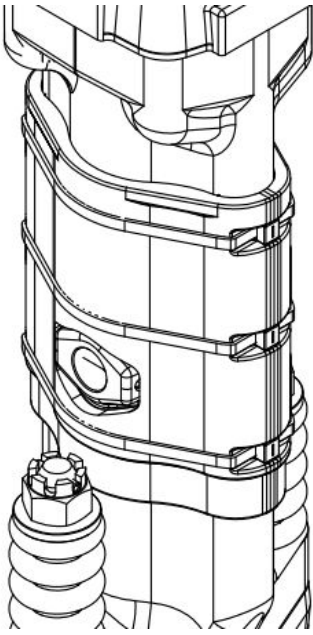
<p>① Remove the oil or dirt from the Cylinder surface.</p>	<p>② Attach the Resin Insulator (Pair) on the Cylinder along the exhaust holes.</p>
	 <p>The lower end put in between Cylinder and Nuts.</p>
<p>③ Attach the three Banding Bands.</p>	<p>④ Tighten Banding Bands so that the Resin Insulator (Pair) is attached firmly to the Cylinder. Then cut off the extra end of bands.</p>
 <p>Banding Bands fit into the grooves of Resin Insulator (Pair).</p>	
<p>⑤ Assemble the Muffler (Pair) onto the Breaker and tighten Screws and Nuts. (8 points) Tightening Torque : 29kgf·cm (3N·m)</p>	

TPB-501SV

Parts List

Exploded View



www.air-allied.com.au

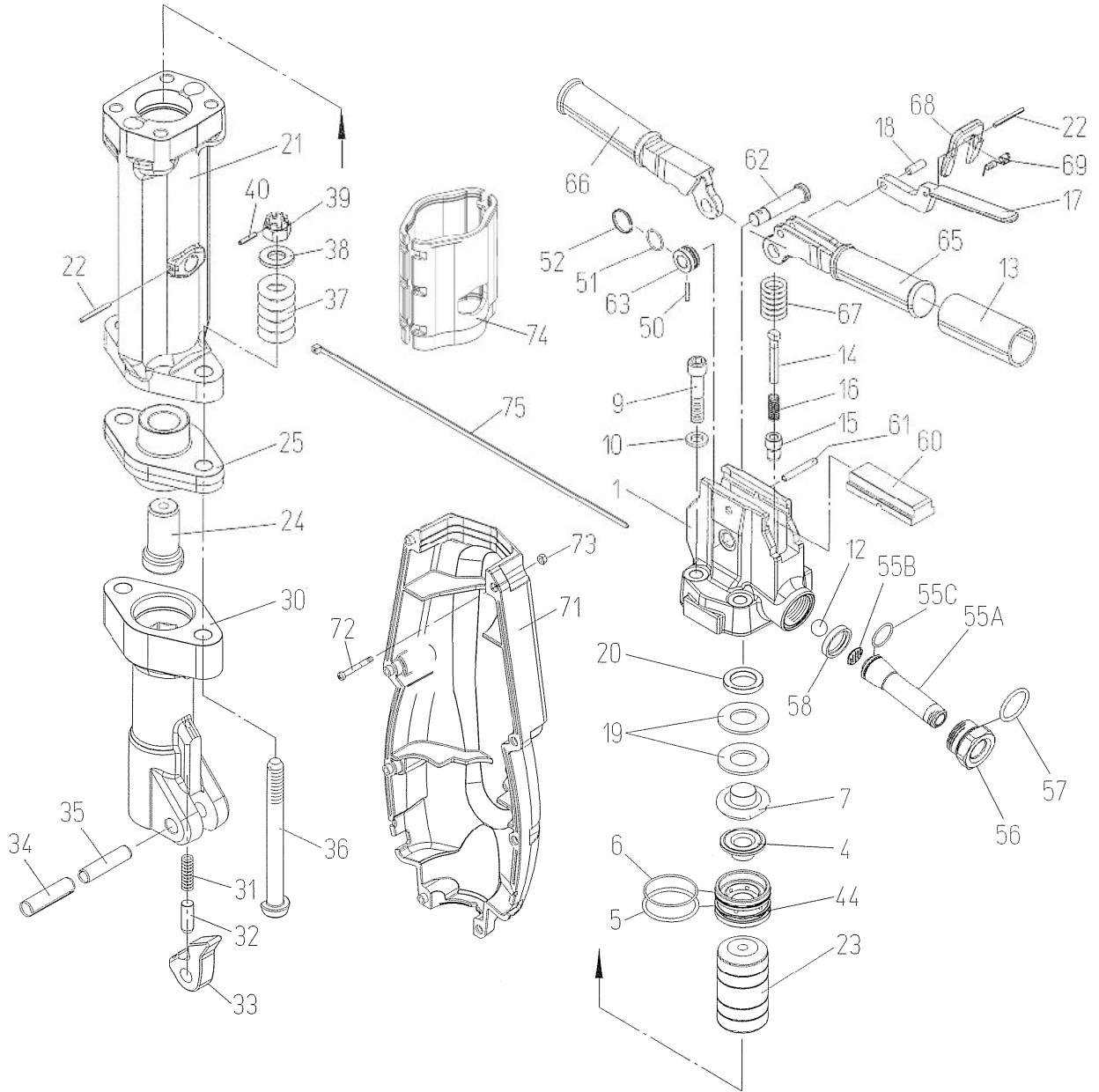

15th edition

TPB-501SV

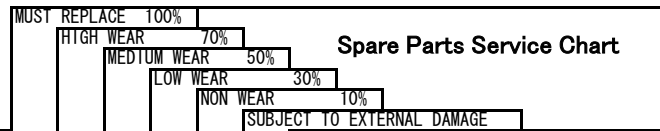

Symbol No.	Parts No.	Q'ty Req.	Description	MUST REPLACE 100%	HIGH WEAR 70%	MEDIUM WEAR 50%	LOW WEAR 30%	NON WEAR 10%	SUBJECT TO EXTERNAL DAMAGE
1	410370490	1	Back Head					X	
4	410231150	1	Valve				X		
5	131101051	1	O-Ring P-49	X					
6	131103039	1	O-Ring S-50	X					
7	410231180	1	Valve Cover					X	
9	131712055	4	Hex Socket Bolt M12X55					X	
10	131301012	4	Spring Washer M12					X	
12	130505048	1	Polyurethane Rubber Ball 3/4					A	
13	136601010	2	Rubber Grip					X	
14	410227C11	1	Valve Pin					X	
15	410227280	1	Valve Pin Bushing					X	
16	130801038	1	Valve Pin Spring			X			
17	410227310	1	Throttle Lever					X	
18	410227330	1	Throttle Lever Pin					X	
19	131313050	2	Coned Disk Spring H-25					X	
20	410362800	1	Spacer Ring					X	
21	410370010	1	Cylinder					X	
22	130604040	3	Spring Pin 4X40					X	
23	410362040	1	Piston			X			
24	410350580	1	Tappet				X		
25	410370590	1	Tappet Seat					X	
30	410370530	1	Front Head 1-1/8					X	
30	410371530	1	Front Head 1-1/4					X	
31	130801062	1	Retainer Plunger Spring			X			
32	410350650	1	Retainer Plunger			X			
33	410350610	1	Steel Retainer	X					
34	130616060	1	Spring Pin 16X60			X			
35	130610060	1	Spring Pin 10X60			X			
36	410350540	2	Front Head Bolt					X	
37	130801063	2	Front Head Bolt Spring					X	
38	410350560	2	Plain Washer					X	
39	134304016	2	Hex Slotted Nut M16					X	
40	130604022	2	Spring Pin 4X22					X	
44	410362190	1	Valve Chest					X	
50	130400043	1	Parallel Pin 4X19.8					X	
51	131117018	1	O-Ring AS568-018	X					
52	130803144	1	Socket Retaining Ring					X	
55A	410231E60	1	Air Inlet Swivel (S)					X	
55B	136801001	1	Air Inlet Screen					X	
55C	131103019	1	O-Ring S-24	X					
56	410231390	1	Air Inlet Swivel Nut					X	
57	131101033	1	O-Ring P-32	X					
58	410231410	1	Air Inlet Swivel Spacer					X	
60	410136D60	1	Back Head Cap			X			
61	130606044	1	Spring Pin 6X44					X	
62	410136A81	1	Center Pin					X	
63	410136C90	1	Center Pin Ring					X	
65	410136070	1	Lever Handle					X	
66	410227080	1	Handle					X	
67	130801064	2	Handle Spring			X			
68	410227760	1	Stop Lever					X	
69	130801034	1	Stop Lever Spring			X			
71	410370C80	1	Muffler (Pair)					X	
72	132405240	8	Screw W/Washer M5X40					X	
73	134602005	8	Serrate Flange Nut M5					X	
74	410370F30	1	Resin Insulator (Pair)					X	
75	137502016	3	Banding Band		X				

This service chart is a guide to expectant life of component parts. The replacement levels are based on average tool usage over a one year period.

Example : For 10 tools in use : 10 must —replace items will be required per year, 7 high wear items, etc.

Note: Quantities must be increased if the tool is in more service or continuous usage.

LEGEND
 X—Type of wear, if no other comments apply.
 A—Easily lost or damaged during disassembly and reassembly.



15th edition

MEMO

